

PRODUTOS ESPECIAIS

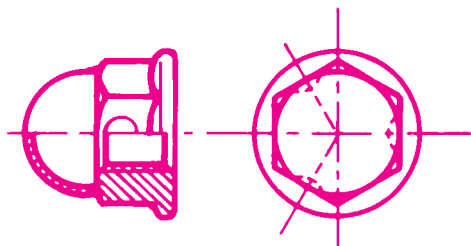

Porca cega autofreada com assento

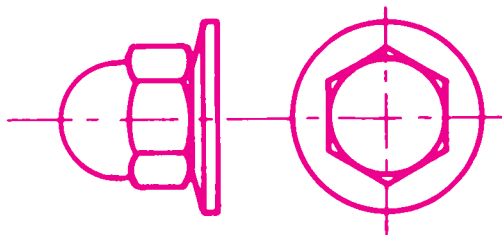

Porca cega com arruela cônica móvel

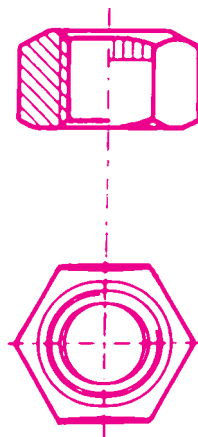

Porca cônica autofreada

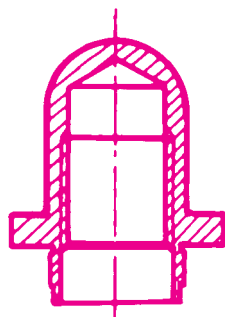

Porca cega de incrustar

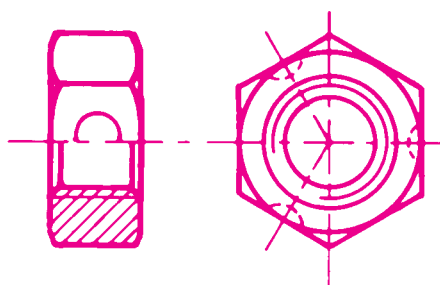

Porca sextavada autofreada (DIN 980)

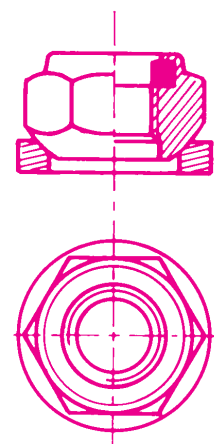

Porca de vão esférica autofreada
ROTULAGEM $\pm 8^\circ$

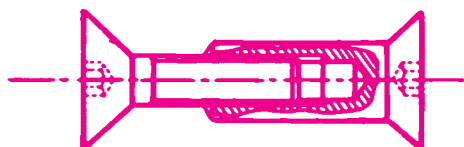

Parafuso porca tipo união

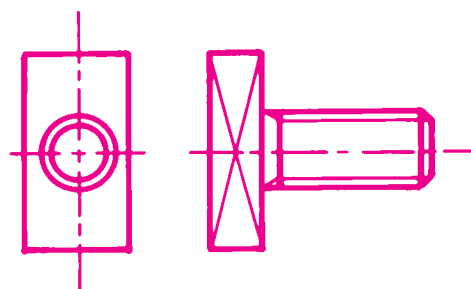

Parafuso $\frac{1}{4}$ de giro

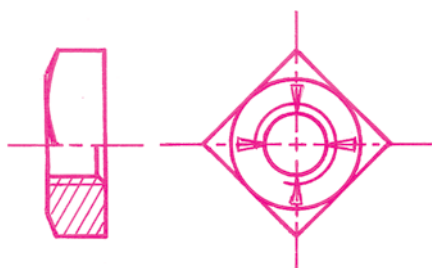

Porca quadrada autofreada

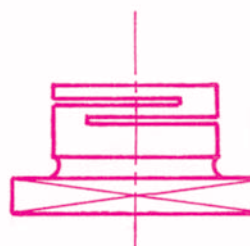

Porca de 2 fendas com cabeça quadrada

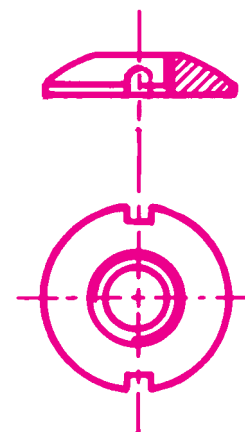

Porca inviolável desmontável

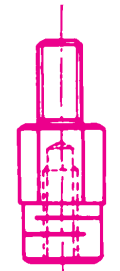

Coluna autofreada

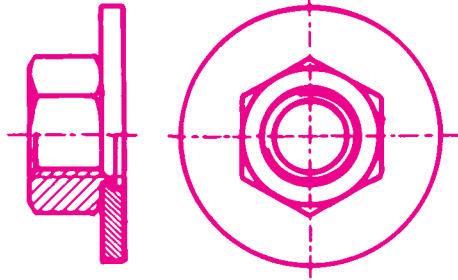

Porca com arruela plana móvel

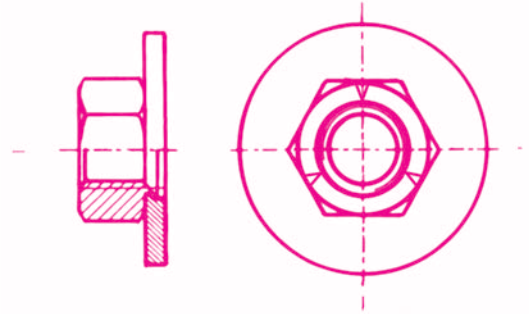

Porca autofreada com arruela plana móvel

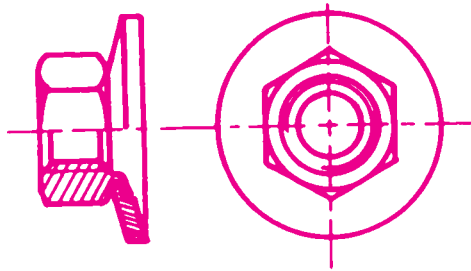

Porca com arruela elástica

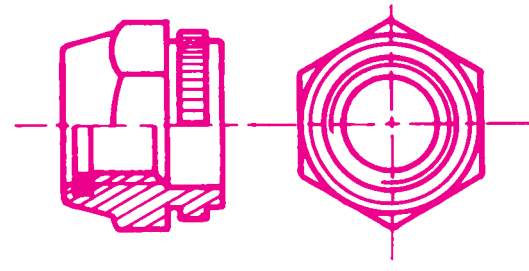

Porca de incrustar com intercalador de nylon

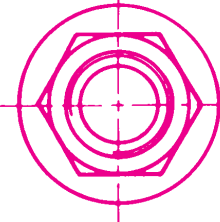
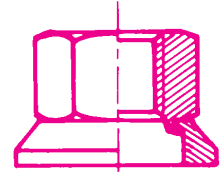

Porca de roda com assento móvel

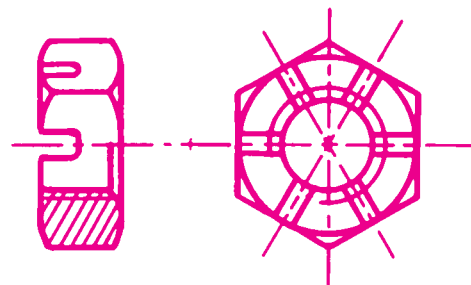

Porca com canelado baixo

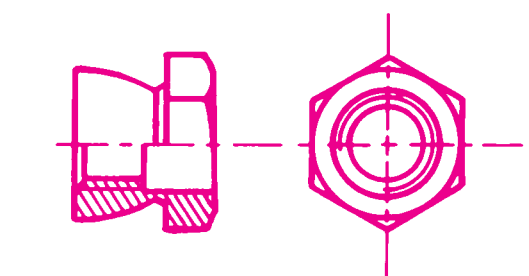

Porca inviolável autoquebrável

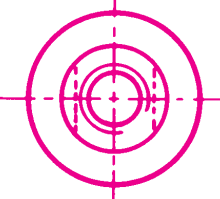
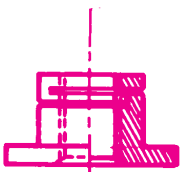

Canhão fresado autofreado

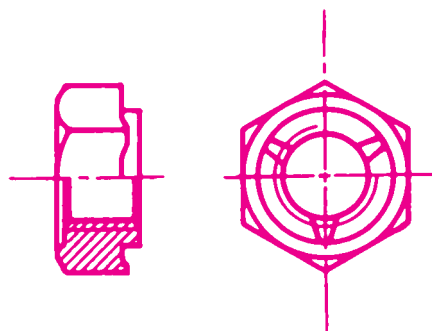

Porca de solda autofreada

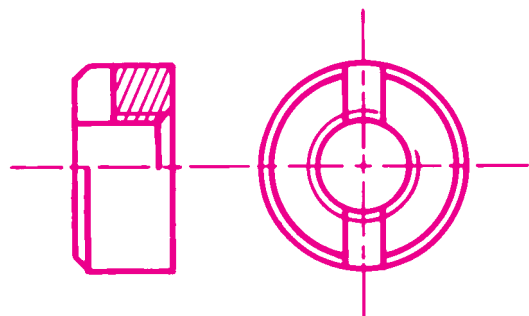

Porca redonda recortada